



RRC-JG05

迷你電飯煲

Mini Rice Cooker



僅供家庭使用
For household use only

使用說明書

OPERATION MANUAL

- 在使用本產品前，請仔細閱讀本說明書，閱讀後小心收藏，以備日後查閱。
Please read the operation manual carefully before using. Keep it in a safe place for future reference.
- 本說明書中的圖示可能有與實物有不同的地方，僅供參考。
The images in the operation manual may not match with the real object and are for reference only.

非常感謝您選購樂信牌迷你電飯煲，使用前請先詳細閱讀本說明書，並保存以備日後參考。



目錄

1. 安全注意事項
2. 保養、清潔及儲存
3. 產品規格
4. 產品說明
5. 使用方法
6. 保溫功能
7. 特別聲明
8. 售後服務



1. 安全注意事項

使用本產品時，必須遵守下列安全措施：

下圖表示由於錯誤操作而引起不同程度的危險等級。

| | |
|---|------------------------------|
|  | 警告: 此標誌表示可能造成傷亡。 |
|  | 注意: 此標誌表示可能造成傷害或財物損失。 |

以下不同標誌區分各種必須遵守的指示。

| | |
|---|-------------|
|  | 此標誌表示禁止。 |
|  | 此標誌表示 必須遵守。 |

|  警告 | | | |
|---|--|---|---|
|  | 切勿讓小孩單獨使用、清潔及維修保養電飯煲或把它當作玩具。請將電飯煲及其電線放於小孩不能觸及的地方。 |  | 為免危險，請按照此說明書建議方法使用，切勿在室外使用或作其他用途。如錯誤操作，可造成傷害。 |
|  | 切勿使用變形的內鍋，以免因與發熱板接觸不良而引致故障。 |  | 使用前，確保電源線兩端的插頭已分別插穩在電飯煲及電源插座上。 |
|  | 切勿讓電飯煲在無人看管下或沒有內鍋或食物時運作。 |  | 手濕時切勿接觸、插入或拔除插頭，否則可構成觸電的危險。 |
|  | 為避免燙傷，使用時或剛使用後，切勿將臉或手靠近上蓋或蒸氣口；切勿觸摸剛使用後的發熱板及內鍋，因仍有餘熱。 |  | 此電飯煲只可作家庭或類似環境使用，如商店內部、辦事處和其他工作環境的員工廚房區域；旅館、汽車旅館和其他住宿類型的環境。 |
|  | 切勿把機身、電源線或插頭浸入水中；或被水濺濕，以免造成觸電及火災。 |  | 切勿使用有殘缺或鬆動的插座。使用前，確保插頭已充分擦乾。 |



警告

| | | | |
|--|--|--|--|
| | 切勿擅自改裝電飯煲或使用非生產商提供的零件進行修理，否則可造成危險及維修保養無效。 | | 使用時，切勿用任何物件覆蓋電飯煲表面或遮擋蒸氣口，以免造成電飯煲故障、變形或變色。 |
| | 此電飯煲可供年齡在8歲或以上的兒童及體質、感覺或智力有障礙人士或缺乏經驗和相關知識的人士使用，但他們必須曾經接受負責安全人士的監督或指導如何安全地使用電飯煲和理解所涉及的危險。 | | 經常檢查電飯煲、內鍋、電源線及插頭，如有損壞，為避免危險，請立即停止使用，並聯絡信興電器服務中心有限公司安排檢查及維修。 |



注意

| | | | |
|--|--|--|--|
| | 切勿使用其他器皿來取代原裝內鍋。 | | 使用時，切勿打開上蓋、移動或搖晃電飯煲，以免造成危險。 |
| | 使用前，確定內鍋外部及發熱板表面清潔乾爽，否則可能引致故障。 | | 切勿使用內鍋直接淘米，並請使用附件的飯勺，以免損害內鍋表面的塗層及影響烹調效果。 |
| | 切勿用火加熱內鍋，否則會損壞內鍋。 | | 切勿用內鍋烹調酸性或鹼性的食物，以免損壞內鍋塗層。 |
| | 煮食份量不可超過內鍋內最高水位線，否則可能有水從蒸氣口噴出。 | | 在插入或拔除插頭時，應用手握穩插頭本身，不要抓住電源線。 |
| | 切勿在電源線纏結的情況下使用或將電源線懸掛在桌子、廚櫃的邊緣或讓它接觸灼熱的表面，否則會損壞電源線。 | | 切勿在以下環境使用電飯煲： <ul style="list-style-type: none"> - 潮濕或近水的環境 - 靠近熱源如電焗爐、電磁爐及火源 - 不平穩的表面上 - 易燃物料或不耐熱物品附近(如枱布、窗簾及毛巾等) |
| | 使用後，拔出插頭及待電飯煲冷卻後才移動、清潔或檢查電飯煲。 | | 不可在電源線上放重物；切勿夾住、改裝、用力拉扯或扭曲電源線。 |

2. 保養、清潔及儲存

1. 清潔前，必須拔除電源插頭，並待電飯煲完全冷卻。
2. 清洗內鍋和內蓋時，請使用海綿等軟性物料及溫和清潔劑，用水沖洗後再抹乾及裝回原位。
3. 如有食物黏在內鍋，清洗前可先用水浸泡一會。
4. 如發熱板、機身或上蓋有污漬，可用濕布抹淨後再抹乾。
5. 為免損壞內鍋塗層，盛飯時請使用原裝飯勺，切勿使用金屬餐具或在內鍋中切割食物。
6. 切勿使用有毒或含腐蝕性的清潔劑或粗硬的潔具(如鋼絲刷)清潔。
7. 長時間使用後，內鍋表面可能會變色，此乃正常現象並不會影響食物安全及內鍋的使用。
8. 儲存時，請將電飯煲放入紙箱並放置在乾爽的環境中。
9. 儲存時，切勿將電源線纏繞在電飯煲四周或壓住電源線，以免造成電源線損壞。

3. 產品規格

| | |
|-----------------|--------------------|
| 型號 | RRC-JG05 |
| 額定電壓 | 220-240伏特~ 50/60赫茲 |
| 額定功率 | 250瓦 |
| 容量 | 0.5升(最多5杯米) |
| 淨重 | 1.35 公斤 |
| 產品尺寸(闊 x 深 x 高) | 181 x 201 x 195毫米 |

4. 產品說明

1. 蒸氣口
2. 上蓋
3. 內蓋蒸氣口
4. 內蓋密封圈
5. 內蓋
6. 內鍋
7. 上蓋扣
8. 手柄
9. 機身
10. 控制面板
11. 量杯
12. 飯勺
13. 電源線

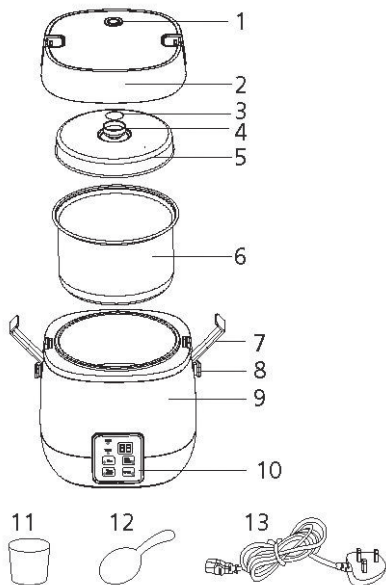

控制面板

1. 顯示屏幕
2. 煲湯/炆煮鍵
3. 煲湯/炆煮指示燈
4. 煲粥鍵
5. 煲粥指示燈
6. 烹調指示燈
7. 保温指示燈
8. 煮飯鍵
9. 煮飯指示燈
10. 保温/取消鍵
11. 保温/取消指示燈

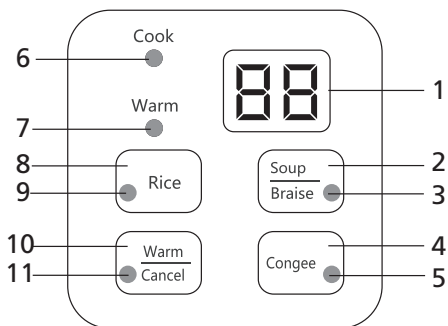

5. 使用方法

各功能的烹調容量及時間如下圖示：

| 烹調功能 | 烹調最少份量 (米量/水量) | 烹調最多份量 (米量/水量) | 默認 烹調時間 | 可調節 時間範圍 |
|-------|--------------------------|--------------------------|------------|-------------|
| 煮飯 | 1杯/ 水位刻度1杯 | 5杯/ 水位刻度5杯 | -- | -- |
| 煲湯/炆煮 | 不可低於 水位刻度1杯 (包括材料) | 不可超出 水位刻度5杯 (包括材料) | 60分鐘 | 60-70分鐘 |
| 煲粥 | 0.5杯/ 水位刻度2杯 | 1杯/ 水位刻度4杯 | 50分鐘 | 50-60分鐘 |
| 保溫 | -- | -- | 8小時 | -- |

※ 煮飯的實際時間會根據米量、水量、電壓、室溫、水溫及米質的不同而變化。

※ 米飯的軟硬會因米量、水量及米質的不同而影響，並有可能產生鍋巴。

※ 用戶可按個人喜好適量地調節水量。

1. 解開上蓋扣及打開上蓋。
2. 將清洗乾淨的米倒入內鍋。請勿在內鍋直接洗米，避免在洗米過程中磨損內鍋表面塗層。

※ 附隨的量杯份量—1杯米平口盛滿約0.1升(約100克)。

3. 加入適量的水。如煮2杯米，請加水至水位刻度2杯的位置。

※ 切勿用熱水煮飯，否則會影響溫控器的溫度判斷及米飯的烹調效果。

4. 蓋上上蓋及鎖上兩旁的上蓋扣，直至聽到“咔答”一聲。

※ 確保內鍋與發熱板充分接觸，鍋內的米量要均勻分佈。

5. 連接電源，顯示屏幕出現“--”，表示處於待機狀態。

6. 直接按功能鍵選擇功能。

※ 按“煮飯”鍵選擇煮飯功能。功能指示燈閃動5秒後轉為長亮及烹調指示燈亮起，表示已進入工作狀態。

※ 如選擇煲湯/炆煮或煲粥功能，按鍵後，顯示屏幕會顯示默認烹調時間。在功能指示閃動時，按功能鍵可調整烹調時間。設定後等待5秒，功能指示燈由閃動轉為長亮及烹調指示燈亮起，表示已進入工作狀態，並開始倒數烹調時間。

7. 烹調後，功能指示燈及烹調指示燈熄滅，而保溫指示燈會亮起，表示電飯煲自動切換至保溫狀態。

※ 轉保溫後，可讓米飯蒸焗10-15分鐘才開蓋食用，這樣米飯會更加鬆軟可口。

8. 當不使用時，按“保溫/取消”鍵取消保溫功能及必須拔出電源插頭。

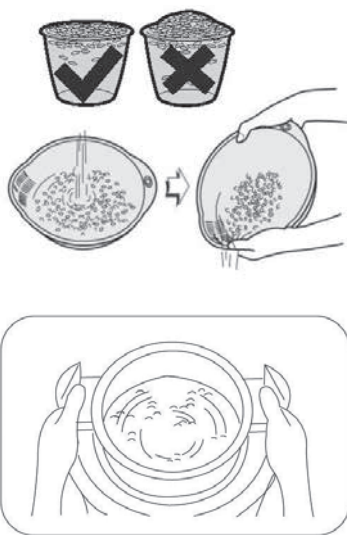

6. 保溫功能

1. 在待機狀態下，按“保溫/取消”鍵可啟動保溫功能，保溫指示燈及保溫/取消指示燈會亮起，顯示屏幕會顯示累計保溫時間。
2. 保溫時，請偶爾將米飯翻鬆及關上上蓋，以免米飯變乾及結塊。
3. 保溫時間最長為8小時，顯示屏幕會顯示從0至7小時累計保溫時間。超過7小時59分鐘後，電飯煲會自動轉為待機狀態。
4. 切勿將米飯或食物保溫過長時間，否則會產生鍋巴、異味或食物變質。
5. 如取消保溫功能，可在保溫狀態下按“保溫/取消”鍵。

7. 特別聲明

1. 本資料上所有內容經過核對，如有任何印刷及內容上的誤解，本公司將保留解釋權。
2. 本產品若有技術改進，會編進新版說明書中，恕不另行通知；產品外觀、顏色如有改動，則以製造商生產資料為準。
3. 如本資料之中英文版本有差異時，應以中文版為準。
4. 使用說明書的電子副本可以通過電子郵件發送致客戶，如有需要，可致電信興電工工程有限公司：28612767。

8. 售後服務

1. 由購買收據日期起之一年保修期內，經信興電器服務中心有限公司之服務人員證實產品故障屬於正常使用之情況下發生者，本公司將提供免費維修或更換零件服務。經更換之任何損壞零件，將歸屬本公司所有。保修範圍不包括修理或更換產品之損耗性零件等。
2. 用戶必須於維修時出示購買收據／換購收據及蓋有銷售點／換購中心印章的產品保修記錄卡。如有任何疑問，請致電信興電器服務中心有限公司熱線：24065666查詢。

Thank you for choosing Rasonic mini rice cooker. Please read the operation manual carefully before use and keep it for your future reference.



Table of Contents

1. Important Safeguards
2. Maintenance, Cleaning and Storage
3. Product Specifications
4. Product Descriptions
5. Operation Instructions
6. Keep Warm Function
7. Special Avowal
8. After Sales Service



1. Important Safeguards







When using the appliance, please follow the below safety precautions:

The following chart indicates the degree of damage caused by wrong operation.

| | |
|---|--|
|  | WARNING: Indicates that may cause death or serious injury. |
|  | CAUTION: Indicates hazards that may cause human injuries or property damages. |









The following symbols can distinguish the instruction types that need to be strictly followed.

| | |
|---|---|
|  | These symbols mean prohibition. |
|  | These symbols mean requirement that must be followed. |

|  WARNING | | | |
|--|--|---|--|
|  | Never allow children to operate, clean, perform maintenance on the appliance alone or play as toy. Please put the appliance and its power cord in a place not reachable by children. |  | To avoid danger, please use the appliance according to the operation manual. Do not use it outdoors or other purpose. Misuse can cause potential injury. |
|  | Do not use deformed inner pot to avoid malfunction due to poor contact with heating plate. |  | Before use, please make sure both ends of the power cord are plugged in tightly on the appliance and the power socket. |
|  | Never leave the appliance unattended when in use or operate without inner pot or food inside. |  | Do not touch, plug in or remove the plug with wet hands, so as not to cause electric shock. |













WARNING

| | | | |
|---|--|---|--|
|  | <p>To avoid burns, do not get your face or hands close to the lid or steam outlet during use or right after use; never touch the heating plate and inner pot which are subject to residual heat right after use.</p> |  | <p>The appliance is intended to be used in household or similar applications such as staff kitchen areas in shops, offices and other working environments; by clients in hotels, motels and other residential type environments.</p> |
|  | <p>Never immerse the main body, power cord or plug in water or let them wet, it can cause electric shock or fire.</p> |  | <p>Do not use deficient or loosen socket. Make sure the plug is dry before use.</p> |
|  | <p>Do not attempt to modify the appliance by yourself or repair with any unauthorized parts, otherwise it will cause hazards and warranty will become invalid.</p> |  | <p>When in use, do not cover the appliance surface or steam vent with any objects to avoid appliance malfunction, deformation or discoloration.</p> |
|  | <p>The appliance can be used by children aged from 8 years and above and persons with reduced physical, sensory or mental capabilities, or lack of experience and knowledge, if they have been given supervision or instruction concerning use of the appliance in a safe way and understand the hazards involved.</p> |  | <p>Always check the condition of the appliance, inner pot, power cord and plug. To avoid hazard, stop using the appliance immediately and contact Shun Hing Electric Service Centre Limited for checking and repairing if any of the parts is damaged.</p> |



CAUTION

| | | | |
|---|--|---|---|
|  | Do not use other container to substitute the original inner pot. |  | Do not open the lid, move or shake the appliance when in use, it can cause danger. |
|  | Make sure the inner pot outer surface and heating plate are clean and dry before use, otherwise it may cause malfunction. |  | Do not wash rice directly inside the inner pot and please use the provided rice scoop, so as not to damage the coating and affect the cooking results. |
|  | Do not heat the inner pot with fire, it will cause damage. |  | Do not cook acidic or alkaline food in the inner pot to avoid damage on the inner pot coating. |
|  | The cooking amount cannot exceed the maximum water level of the inner pot to prevent water from spilling from the steam vent. |  | Grasp the plug itself when plug in or remove the plug, do not grasp the power cord. |
|  | Do not operate the appliance when the power cord is tangle or hang the power cord over the edge of table, counter-top or let it touch any hot surface, it may cause power cord damage. |  | Do not operate the appliance in the following places: <ul style="list-style-type: none">- Humid environment or near water- Near heat sources such as electric oven, induction cooker and fire- On unstable surface- Near inflammable or non-resistant to heat objects (e.g. table cloth, curtain and towel etc.) |



CAUTION



After use, unplug the plug and let the appliance cool down before moving, cleaning or checking.



Do not place heavy objects on the power cord. Never clip, modify, stretch or twist the power cord.

2. Maintenance, Cleaning and Storage

1. Before cleaning, unplug the plug and let the rice cooker cool down completely.
2. When clean the inner pot and lid, please use soft material such as sponge and mild detergent. Rinse with water and rub them dry. Put them in place after cleaned.
3. If food residual sticks on the inner pot, please soak the inner pot with water for a while before cleaning.
4. If dirt is attached on the heating plate, main body or lid, use a damp cloth to clean and wipe them dry.
5. To avoid damage on the inner pot coating, please use original rice scoop when serving rice, never use metal utensils or cut food in the inner pot.
6. Never use poisonous or corrosive detergent or harsh tools (e.g. metal-wired brush) for cleaning.
7. The color of inner pot may change after using a period of time, however it does not affect the food hygiene and function of the inner pot.
8. When store, put the appliance in a box and store in a dry place.
9. When store, never wrap the power cord around the appliance or clip the power cord to prevent power cord damage.

3. Product Specifications

| | |
|--------------------------|----------------------------|
| Model | RRC-JG05 |
| Rated Voltage | 220-240V~ 50/60Hz |
| Rated Power | 250W |
| Capacity | 0.5L (Max. 5 cups of rice) |
| Net Weight | 1.35 kg |
| Product Size (W x D x H) | 181 x 201 x 195 mm |

4. Product Descriptions

1. Steam vent
2. Lid
3. Inner lid steam vent
4. Inner lid sealing ring
5. Inner lid
6. Inner pot
7. Lid lock
8. Handle
9. Main body
10. Control panel
11. Measuring cup
12. Rice scoop
13. Power cord

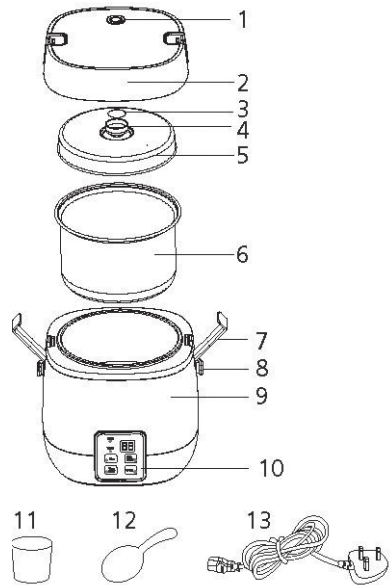

Control Panel

1. Display screen
2. Soup/Braise button
3. Soup/Braise indicator light
4. Congee button
5. Congee indicator light
6. Cook indicator light
7. Keep-warm indicator light
8. Rice button
9. Rice indicator light
10. Keep-warm/Cancel button
11. Keep-warm/Cancel indicator light

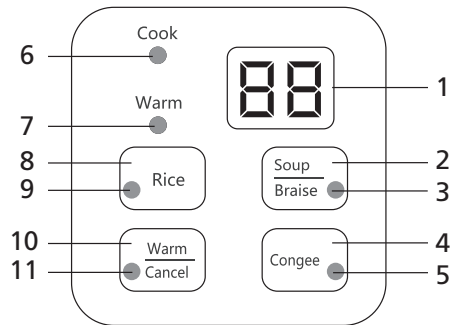

5. Operation Instructions

Below is the table of each function's cooking capacity and time:

| Cooking function | Min. amount (Rice/water capacity) | Max. amount (Rice/water capacity) | Default cooking time | Adjustable time range |
|------------------|---|---|----------------------|-----------------------|
| Rice | 1 cup / 1-cup water level | 5 cups / 5-cups water level | -- | -- |
| Soup/Braise | Not less than 1-cup water level (Incl. ingredients) | Not exceed 5-cups water level (Incl. ingredients) | 60 mins. | 60-70 mins. |
| Congee | 0.5 cup / 2-cups water level | 1 cup / 4-cups water level | 50 mins. | 50-60 mins. |
| Keep-warm | -- | -- | 8 hrs. | -- |

- ※ The actual rice cooking time is varied with different rice quantity, water amount, voltage, room temperature, water temperature and rice quality.
- ※ The rice texture is affected by different rice quantity, water amount and rice quality which are even possible to form crust.
- ※ The water amount can be adjusted accordingly to personal preference on the rice texture.

1. Release the lid lock and open the lid.
2. Put the rinsed rice in the inner pot. Do not wash rice directly inside the inner pot to avoid scratching the coating.
 - ※ Use the supplied measuring cup to measure rice – 1 full cup of rice is around 0.1L (Around 100g).
3. Add proper amount of water. To cook 2 cups of rice, please add water to 2-cups water level.
 - ※ Do not cook with hot water, it will affect the thermostat operation and the rice texture.

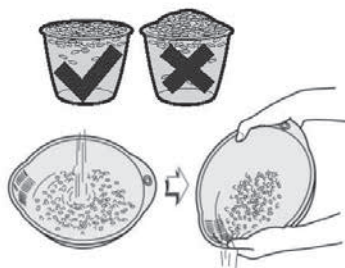

4. Close the lid and lock the lid lock until a "click" sound is heard.

※ Make sure the inner pot is fully in contact with the heating plate and the rice is evenly distributed in the inner pot.

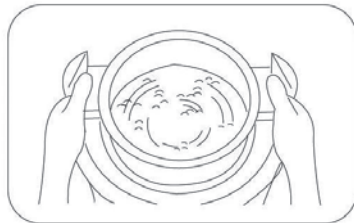

5. Connect the power, the display screen shows "--", it is in the stand-by status.

6. Directly press function button to select the function.

※ Press "Rice" button to select rice function. The function indicator light flashes for 5 seconds, it changes to stay on and the cook indicator light is also on. It means it is in the operation status.

※ If selected soup/braise or congee functions, the display screen will show the cooking time after pressed the function button. When the function indicator light is still flashing, press the function button to adjust the cooking time. Wait for 5 seconds after setting, the function indicator light changes to stay on and the cook indicator light is also on. It means it is in the operation status and it will start to countdown the cooking time.

7. After cook, the function and cook indicator light will be off. The keep-warm indicator light will be on. The rice cooker will switch to keep warm status automatically.

※ It is recommended to keep the rice in keep-warm status for 10-15 minutes, the rice would become soft and taste better.

8. After use, press "Keep-warm/Cancel" button to cancel the keep-warm function and must unplug the plug.

6. Keep warm function

1. In the standby status, press "Keep-warm/Cancel" button to activate the keep-warm function, the keep-warm indicator light and the keep warm/cancel indicator light will be on, the display screen will show the accumulated keep-warm time.

2. During keep warm, please scarify the rice occasionally and close the lid. It is to avoid the rice becomes dry and clamp.

3. The maximum keep-warm time is 8 hours, the display screen will show the accumulated keep-warm time from 0 to 7. After 7 hour and 59 minutes, the rice cooker will then turn to standby status automatically.

4. Do not keep warm the rice or food for too long, otherwise it may have crust, bad smell or deterioration.

5. Press "Keep-warm/Cancel" button under the keep-warm status to cancel the keep warm function.

7. Special Avowal

1. The content in the operation manual has been checked. Our company reserves the hermeneutic power to any printing errors or misunderstanding on the content.
2. If there are technical improvements on the appliance, the operation manual will be updated in new version without prior notice. The product appearance and specification are subject to the manufacturer information.
3. In case there is any inconsistency or conflict between the English versions and Chinese versions of the terms, the Chinese versions shall prevail.
4. E-copy of user manual can be sent by e-mail on request, please call Shun Hing Electric Works & Engineering Co., Ltd. at 2861 2767.

8. After Sales Service

1. For any defect, in the judgement of technician from Shun Hing Electric Service Center Limited, caused under normal use, our company is responsible for repairing or replacing parts of the said electrical appliance free of charge within one year guarantee period commencing from the date of purchase. Any defect part which has been replaced shall become our property. Guarantee service does not cover the repair or replacement of consumable parts etc.
2. User must present the official invoice/redemption voucher and the product warranty card with the chop from sales point/redemption center for maintenance. For enquiries, please call Shun Hing Electric Service Center Limited hotline at 2406 5666.



Rasonic 樂信牌

信興電工工程有限公司

SHUN HING ELECTRIC WORKS AND ENGINEERING CO., LTD.

辦公室：香港九龍尖沙咀東部麼地道67號半島中心9樓

電話：2861 2767

網址：<http://www.rasonic.com>

圖文傳真：2865 6706

電郵：shew@shunhinggroup.com

Office: 9/F, Peninsula Centre, 67 Mody Road, Tsimshatsui East, Kowloon, Hong Kong

Tel: 2861 2767

Fax: 2865 6706

Website: <http://www.rasonic.com>

E-mail: shew@shunhinggroup.com

保養及維修 Maintenance and Repair Service:

信興電器服務中心有限公司

SHUN HING ELECTRIC SERVICE CENTRE LTD.

香港新界葵涌勝耀街2號信興中心11樓

服務熱線：2406 5666

傳真號碼：2408 0316

網址：<http://www.shesc.com/zh>

11/F, Shun Hing Centre, 2 Shing Yiu Street, Kwai Chung, N.T. HK

Service Hotline: 2406 5666

Fax No.: 2408 0316

Website: <http://www.shesc.com/en>

客戶服務中心：

香港新界葵涌勝耀街2號信興中心1樓

九龍尖沙咀東部麼地道67號半島中心B座9樓

香港天后琉璃街7號柏景中心22樓

澳門慕拉士大馬路193-199號南嶺工業大廈5樓1座

Customer Service Centres:

1/F, Shun Hing Centre, 2 Shing Yiu Street, Kwai Chung, N.T.

9/F, Block B, Peninsula Centre, 67 Mody Road, Tsim Sha Tsui East, Kowloon

22/F, Parkview Centre, 7 Lau Li Street, Tin Hau, Hong Kong

Avenida de Venceslau de Moraes, No. 193-199, 5 andar - I, Edf. Industrial Nam Leng, Macau

有關最新之香港及澳門客戶服務中心資料，請參閱信興服務中心網址：<http://www.shesc.com/zh>

For the latest information of Hong Kong and Macau service center, please visit <http://www.shesc.com/en>